REVELATOR R1

CONDENSATION TESTING DEVICE



INSTRUCTIONS



LEAK TESTING & WATCHMAKER TOOLS

Rue du Collège 92

CH – 2300 La Chaux-de-Fonds

Tél : +41 (0)32 967 86 86 Fax : +41 (0)32 967 86 87

email : info@roxer.ch



summary

1) General:.....	3
2) Getting Started:.....	3
2.1) Normal operation:.....	4
3) Menu Programming (PRG):	5
3.1) Creating or editing program:.....	5
3.2) Programming values:.....	6
3.3) Delete a program:	7
3.4) <i>Copy a program</i> :.....	7
3.5) <i>Cooling mode menu</i> :	7
4) Select program menu (SEL) :	7
5) Various menu (DIV) :	8
5.1) Menu »PARAM« :	8
5.2) Menu « setting » :	9
5.2.1) key « LCD » :	9
5.2.2) key « LANGUAGE » :	9
5.2.3) Audible alarm key:.....	10
5.2.4) key « PASS » :	10
5.2.4) key « ACCES » :	10
6) Setting choice :	11
6.1) Heating time setting (time heating) :	11
6.2) Head cold setting (cooling temperature) :	11
6.3) Thermal shock setting time (Contact time) :	12
6.4) Default setting:.....	12
6.5) Setting by successive time:	12

1) General:

The Revelator is a device used to substitute advantageously the test of "drop".

The Revelator can store up to 20 different test programs

The advantages are:

- Element temperature regulated cold and stable.
- Test with heavy ice. (ineffective with the straw)
- Time controlled phases.

! The room temperature control should not exceed 30 ° C.

2) Getting Started:

Switch on the rear panel of the unit and wait for head regeneration to begin work.

Home page display.

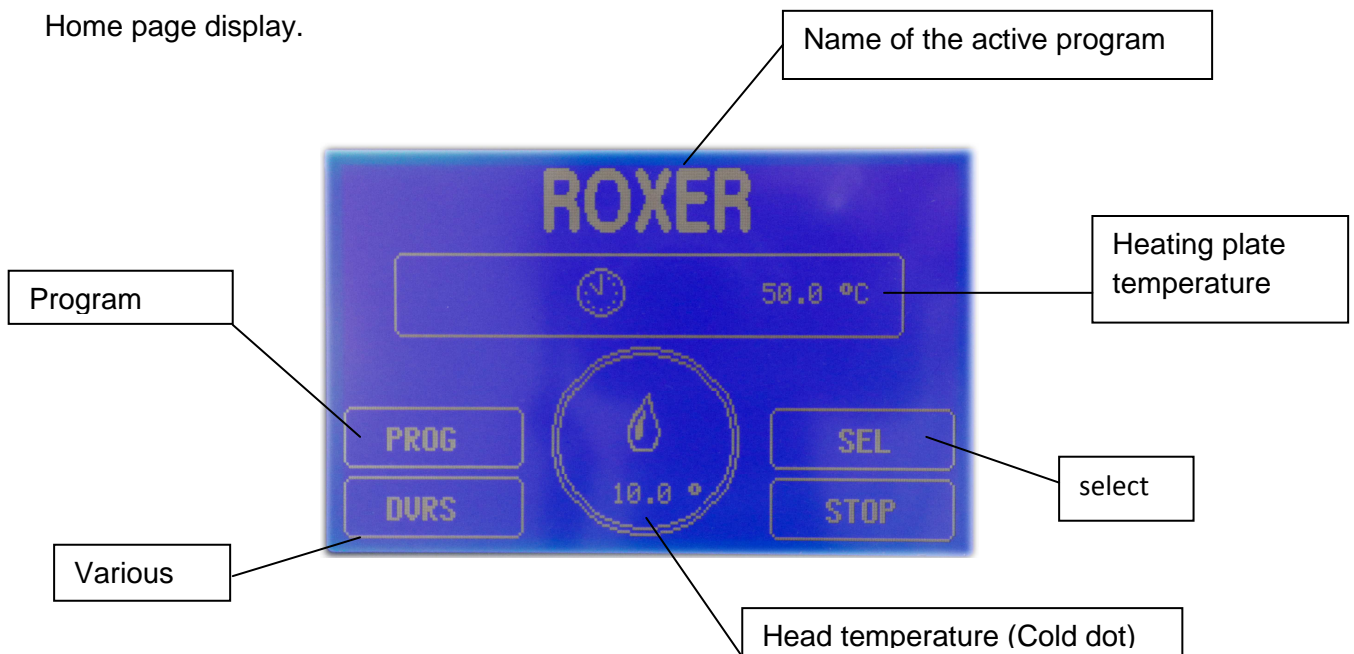

2.1) Normal operation:

-Place the cups on watches! **GLASS DOWN.**

The start-cycle test is performed by pressing the "cold touch".

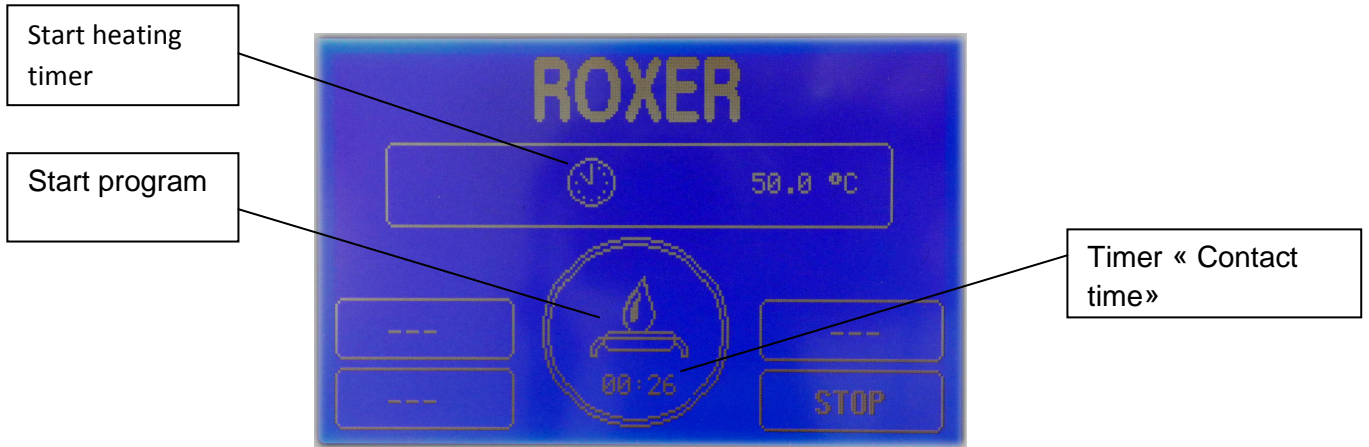

-At the end of timer "contact time" timer "time visu" starts up, it defined the time to control formation of condensation.

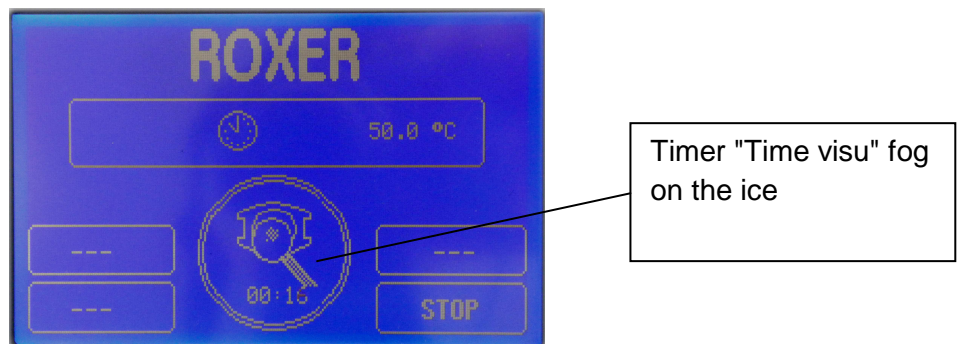

-At the end of timer "Time visu" the following screen appears indicating that the delay of visual inspection is completed.

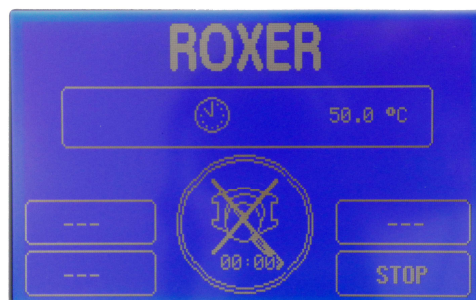

3) Menu Programming (PRG):

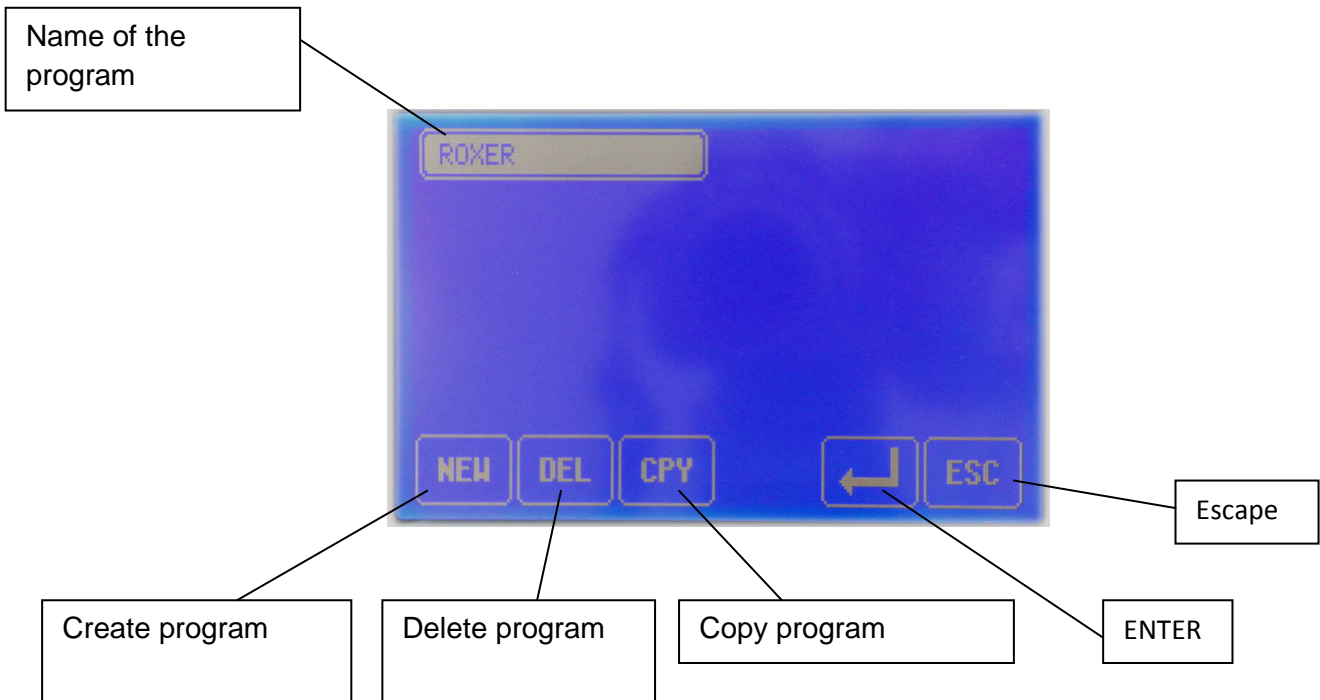

3.1) Creating or editing program:

- Press the "NEW" or "ENTER" in menu "PRG"
- Enter the new name of the program (for NEW)
- Validate

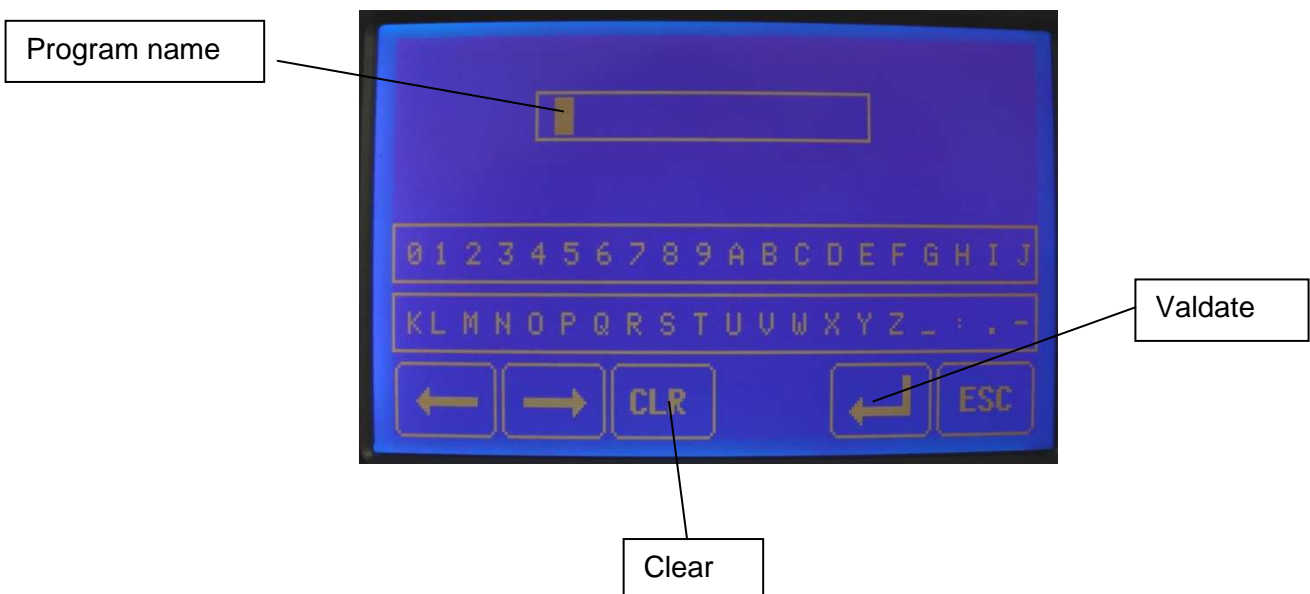

3.2) Programming values:

- Write all the parameters and confirm them only on page 2.

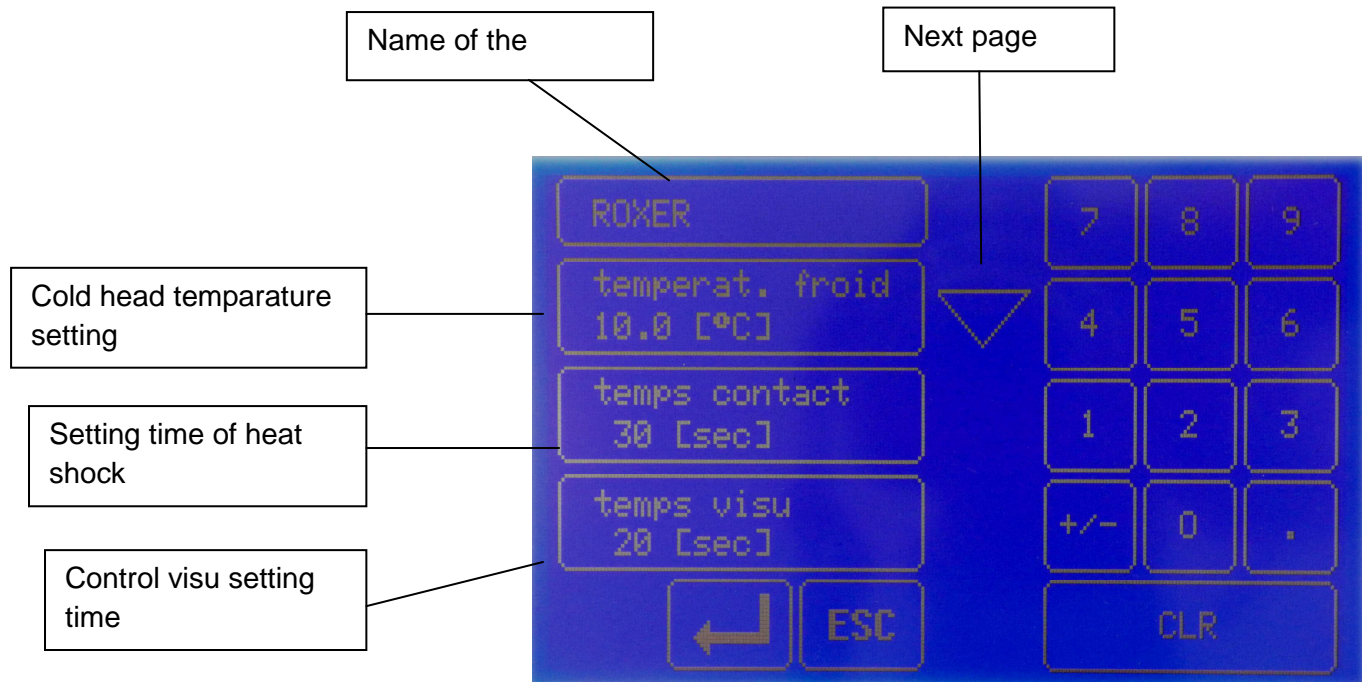

Page 1

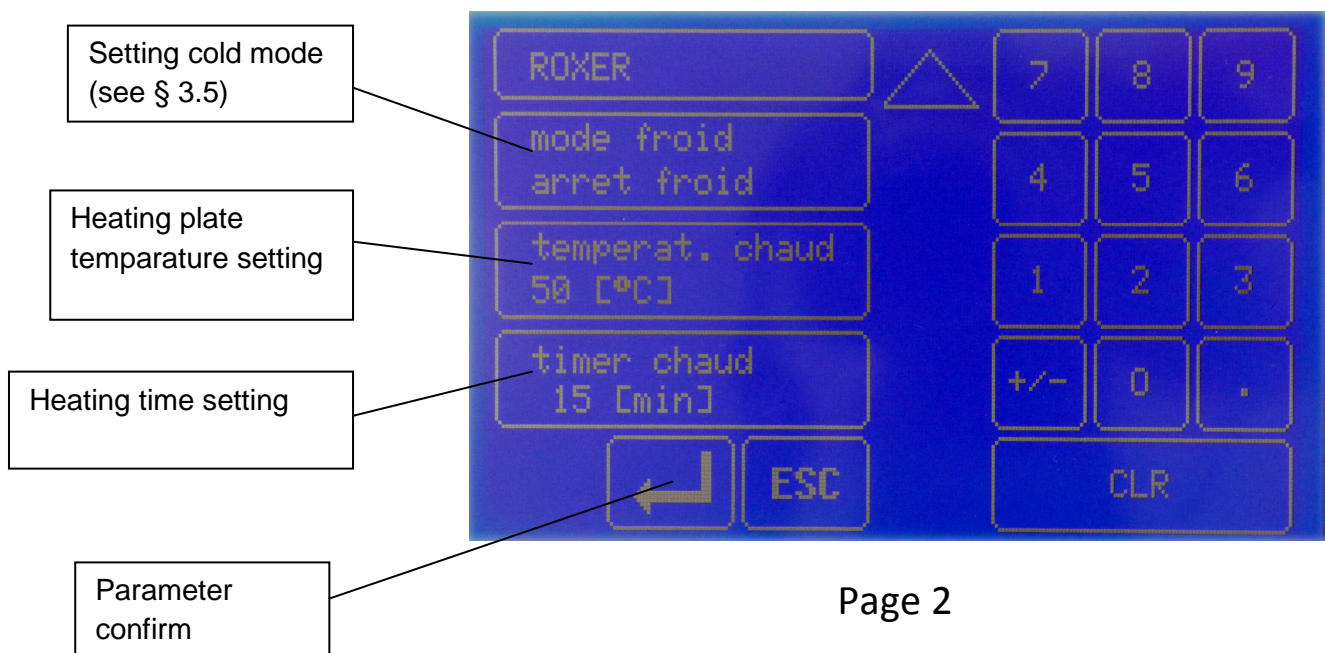

Page 2

3.3) Delete a program:

- Select the program from menu "PROG" and press "DEL".
- Confirm your choice.

3.4) Copy a program:

- Select the program to copy in menu "PROG" and press "COPY".
- Provide a new name in the program (see § 3.1).
- Change the parameters values as necessary (see § 3.2).

3.5) Cooling mode menu:

Continuous cold: Cold still be controlled at the set temperature during heat shock.

Stop Cold: Cold is cut during the heat shock.

4) Select program menu (SEL) :



5) Various menu (DIV) :

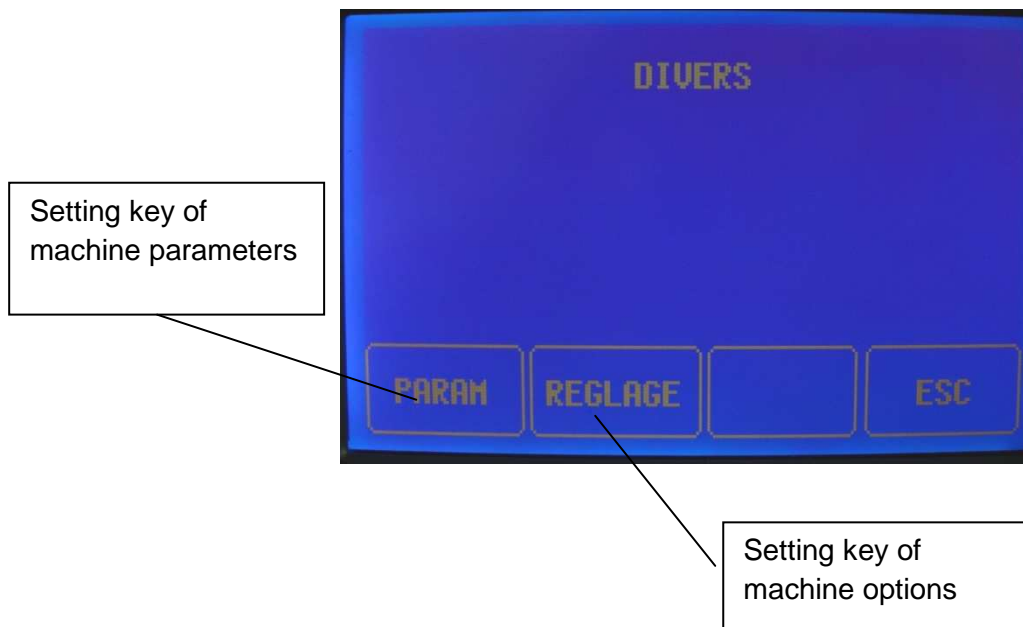

5.1) Menu »PARAM» :

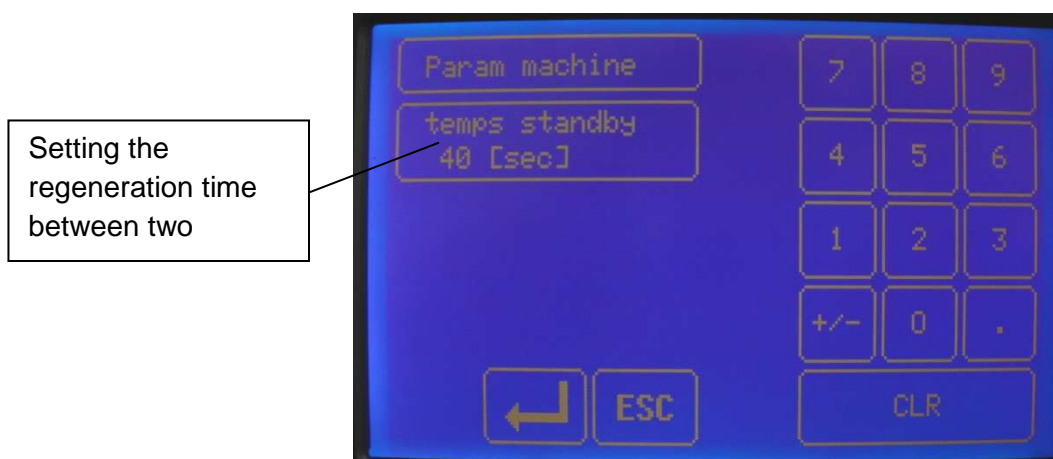

5.2) Menu « setting » :

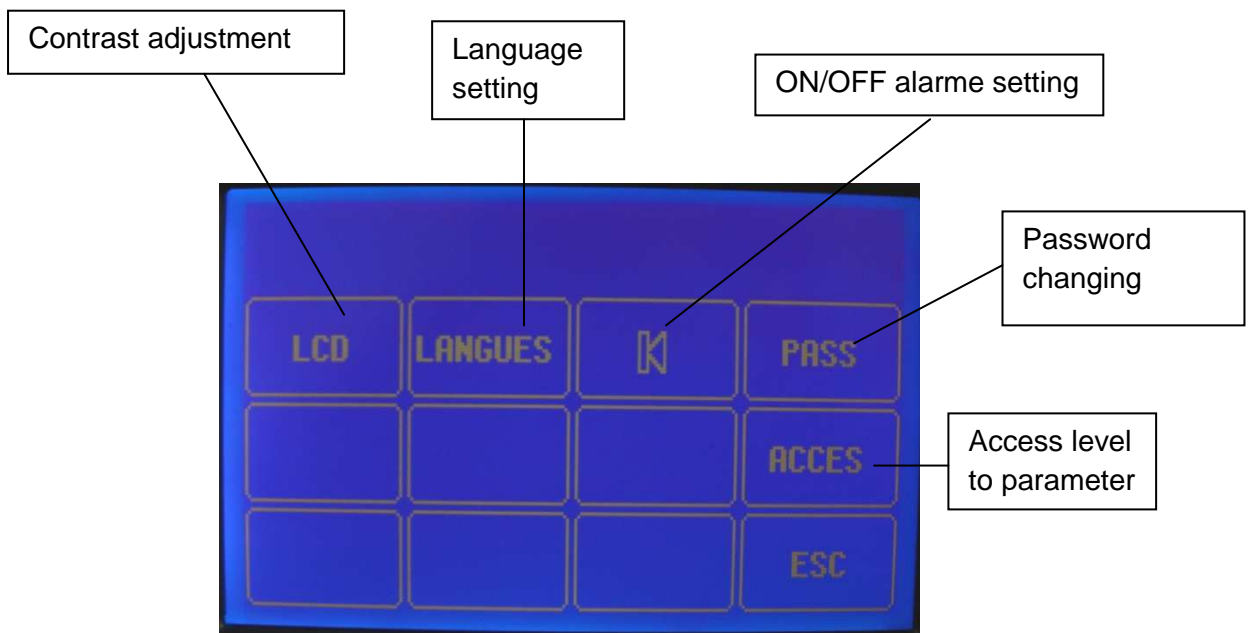

5.2.1) key « LCD » :

-Move the bar chart on the right or left to adjust the brightness.

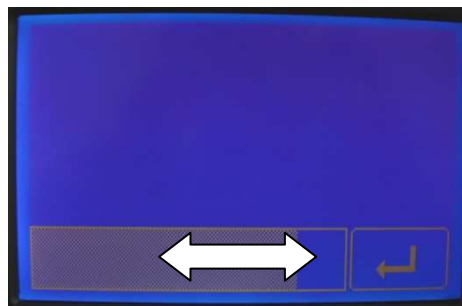

5.2.2) key « LANGUAGE » :

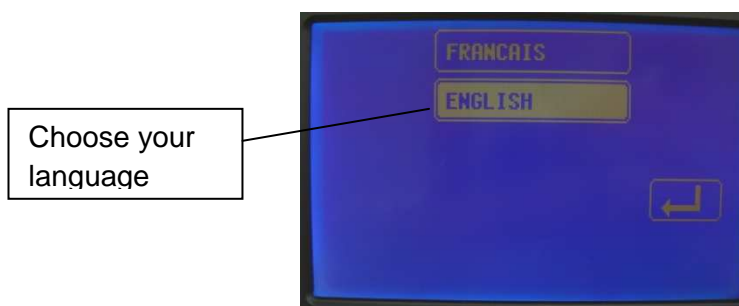

5.2.3) Audible alarm key:

- Press the key  to activate or deactivate the sound.
- choose « with or without»



- Validate.

5.2.4) key « PASS » :

Original password : 1111

- Enter the old password.
- enter the new password

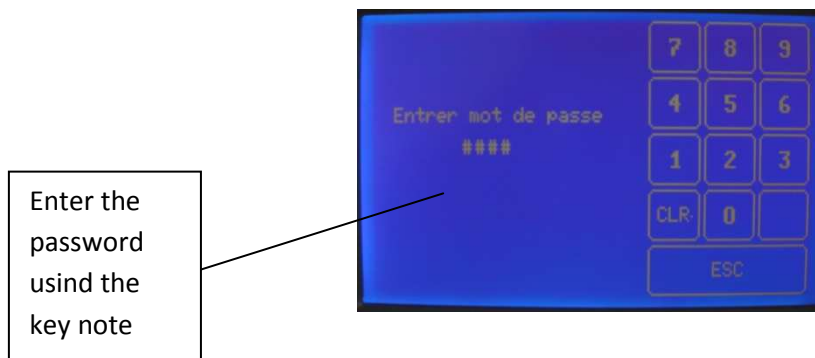

5.2.4) key « ACCES » :

- the key « ACCES » allows to choose the access level parameters

LEVEL 0 : Free access

LEVEL 1 : « PRG » & « PARAM » blocked

LEVEL 2 : « PARAM » (default activation) blocked

LEVEL 3 : All menus are blocked

6) Setting choice :

! In the area of heat shock, only empirical testing and can correctly set the Revelator. Here we give some examples as a basis for adjustments. These examples are there to guide the user but do not commit Roxer SA

6.1) Heating time setting (time heating) :

The standard (NIHS) advises a heating time between 10 and 20 min.

It is not enough to raise the watch at 45 ° C by conduction, it is necessary that all the air inside the watch has reached this temperature. For most watches, what time is adjusted to 15 min.

! Do not forget that a warm-up time too long can evaporate the moisture contained in a watch with a leak. The test will be worthless.

6.2) Head cold setting (cooling temperature) :

The standard (NIHS) recommends a temperature of the cold element (drop in this case) between 18 ° C and 25 ° C.

Thermal shock is a sudden temperature difference inside the watch just under the ice at the center thereof.

From experience, the chart below has been established for watches with flat glass. It should subtract 1 or 2 two degrees depending on the radius of curvature of the ice.

! Too violent a shock causes the vapors due to relative humidity during assembly of the watch.

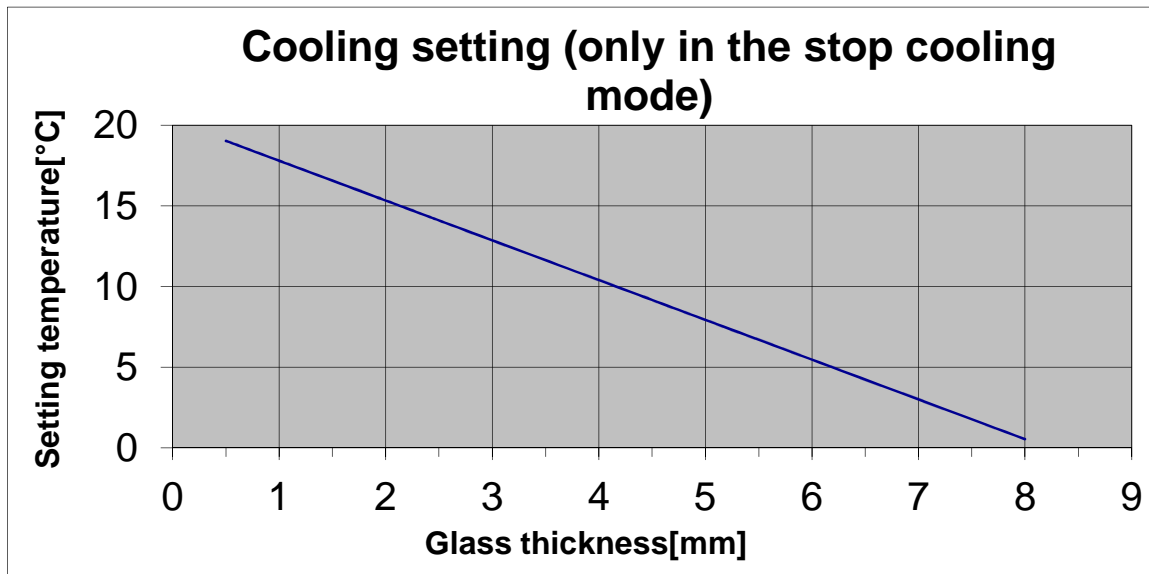

6.3) Thermal shock setting time (Contact time) :

The standard (NIHS) suggest a thermal shock of 60 seconds.

Unlike the test at the drop of water or it warms up a hot time on the ice, the Revelator maintaining the cold (in "Cold continuous). A shorter time is advisable and usually it is 30 seconds.

6.4) Default setting:

Heating timer	15	minutes
Cooling temperature	10	°C
Contact time	30	secondes
Visu time	20	secondes

6.5) Setting by successive time:

If in doubt you can put the settings too severe a test shows known to be tight and if condensation forms (moisture mounting) reduce the severity of settings until there is more mist. Then further reduce the safety margin settings as these settings and validated.